

**XTOOL**

# Standgerät für Self-Service-Kiosk

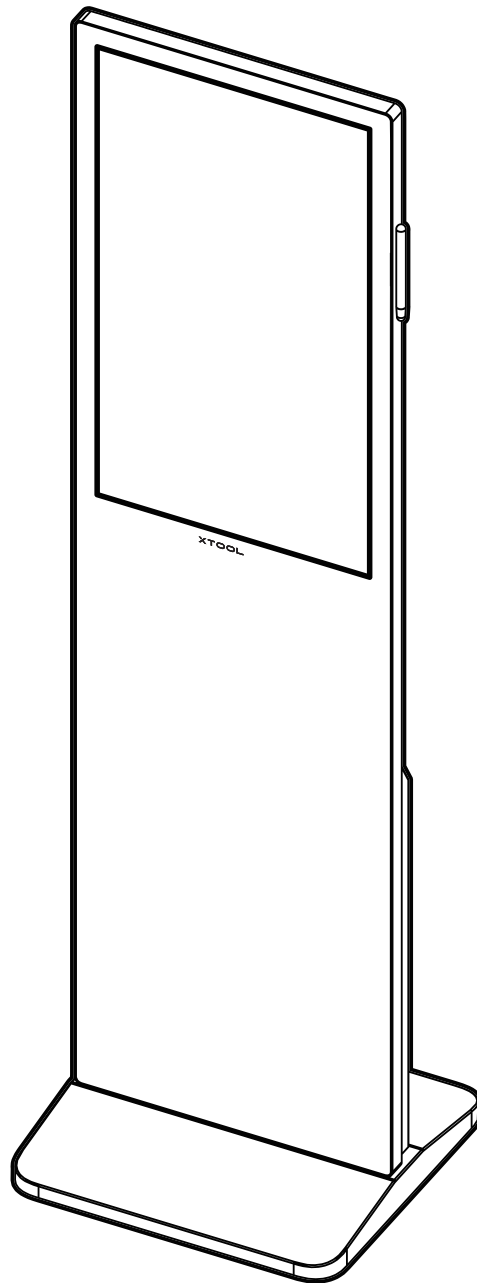

**Kurzanleitung**

**Liste der Teile** - - - - - **01**

**Kennenlernen des xTool Standgerät für  
Self-Service-Kiosk** . - - - - - **02**

**Installation des xTool Standgerät für  
Self-Service-Kiosk** - - - - - **04**

**Verwendung des xTool Standgerät für  
Self-Service-Kiosk** - - - - - **06**

## Liste der Teile

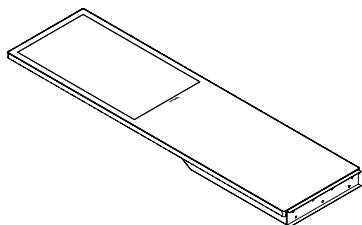

Self-Service-Kiosk

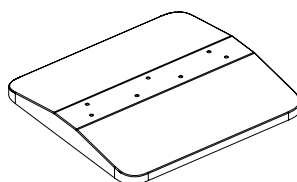

Standfuß

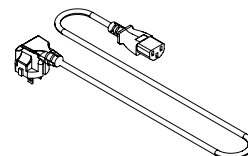

Netzkaabel

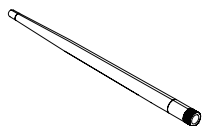

Antenne

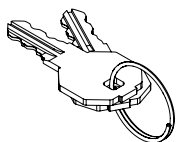

Wartinungsschlüssel

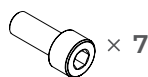

Schraube

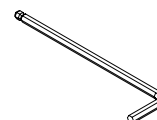

Inbusschlüssel

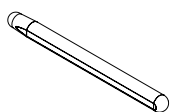

Eingabestift



Kurzanleitung



Sicherheitshinweise



Die Ausführung des Netzkaabels hängt von der Region ab, in die das Produkt geliefert wird.

## Kennenlernen des xTool Standgerät für Self-Service-Kiosk

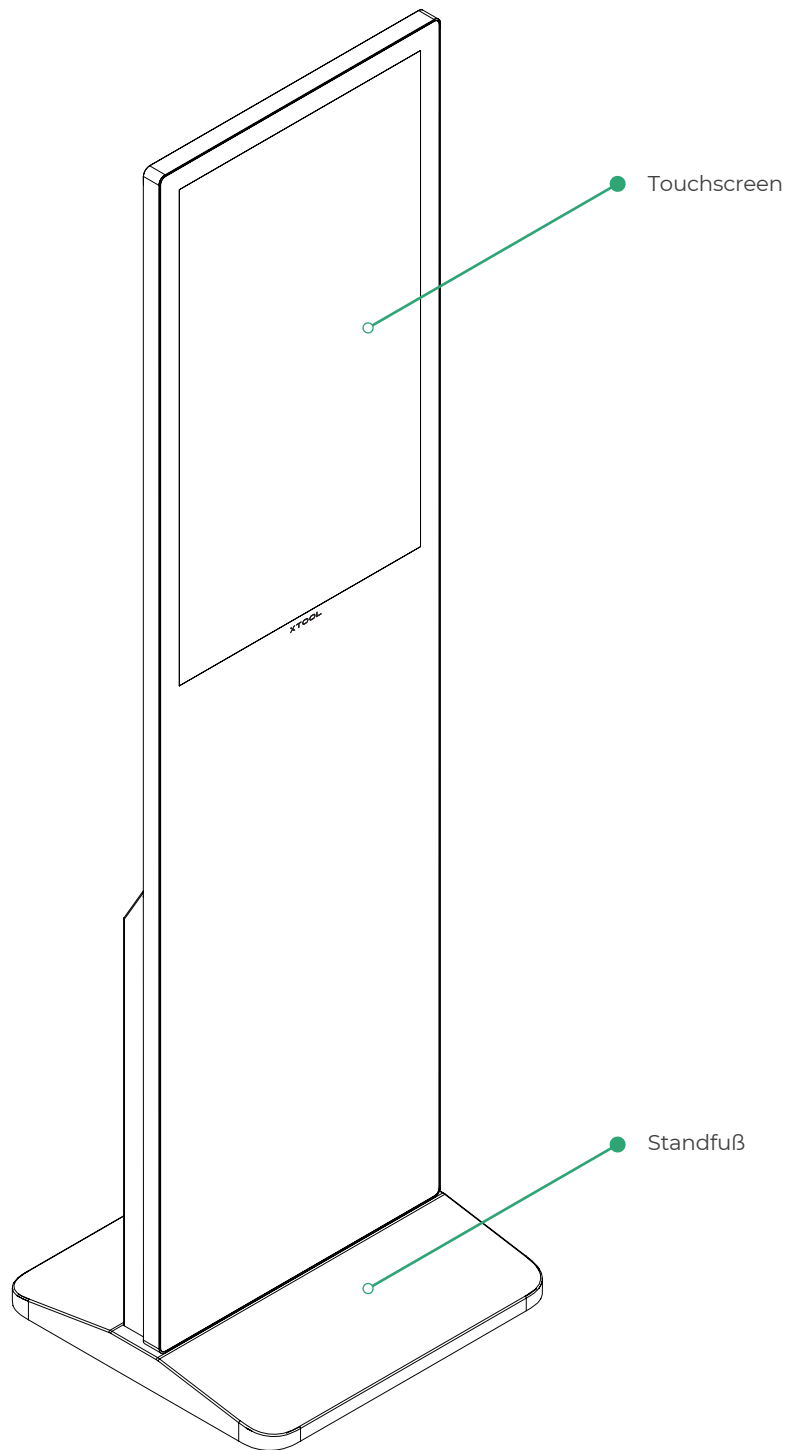

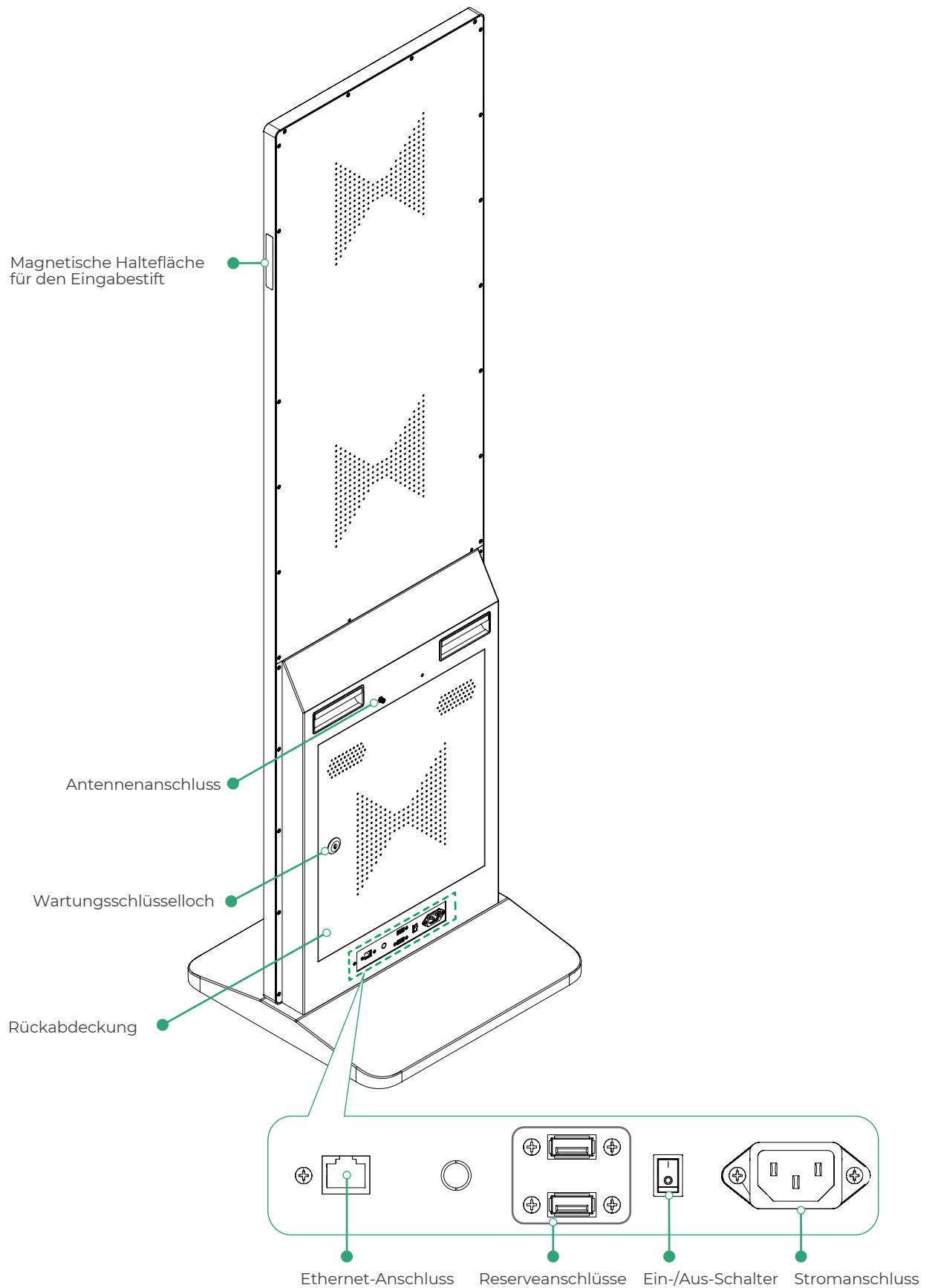

 Die Rückabdeckung darf nur im Wartungsfall mit dem Wartungsschlüssel geöffnet werden.

# Installation des xTool Standgerät für Self-Service-Kiosk

## 1 Montieren Sie den Standfuß

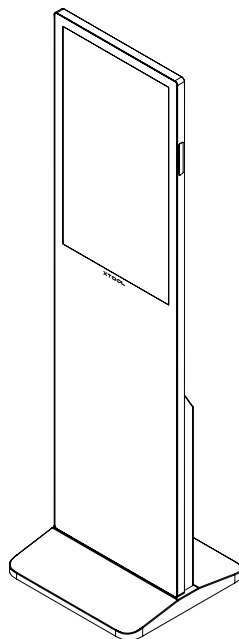
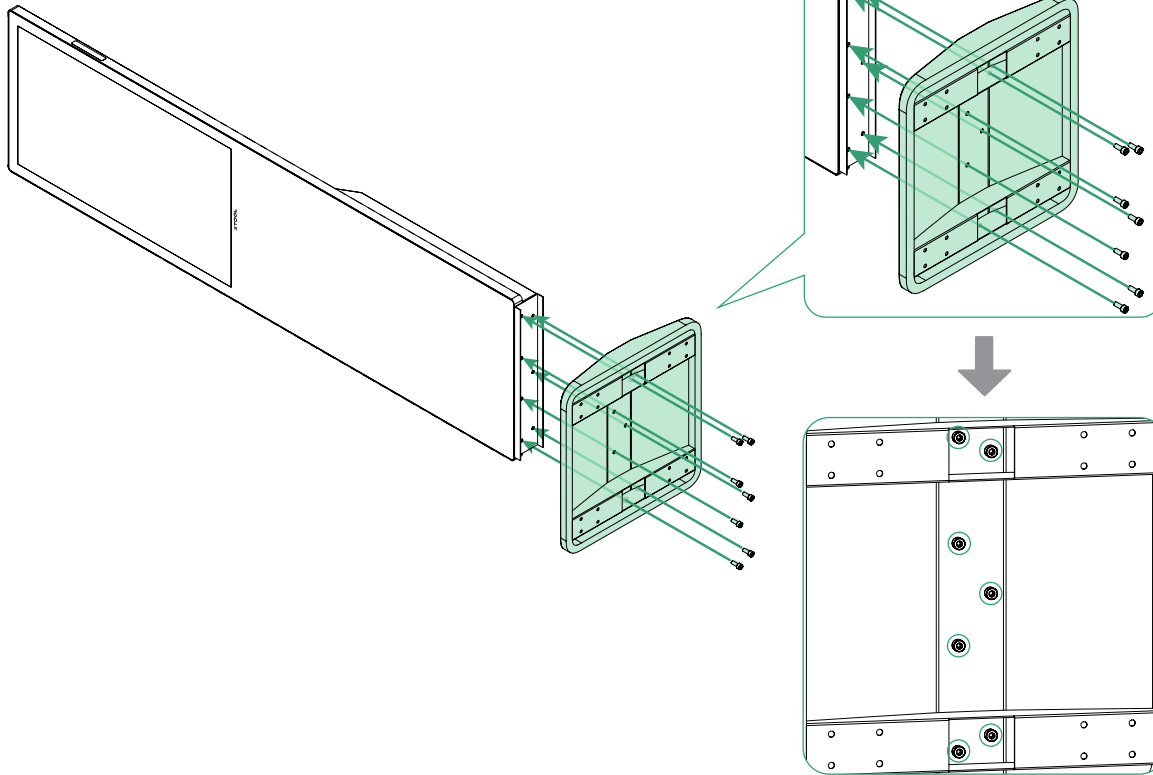
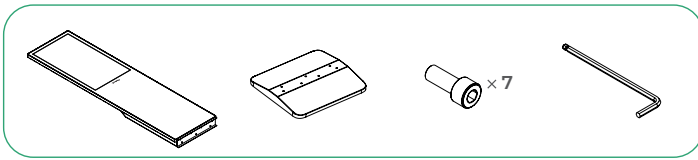

## 2 Befestigen Sie die Antenne

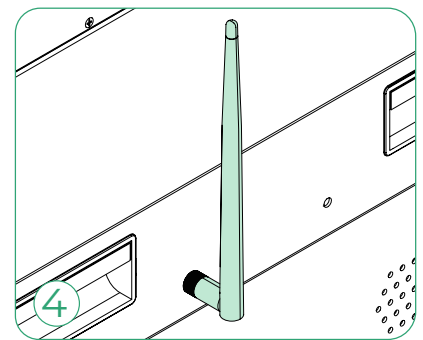
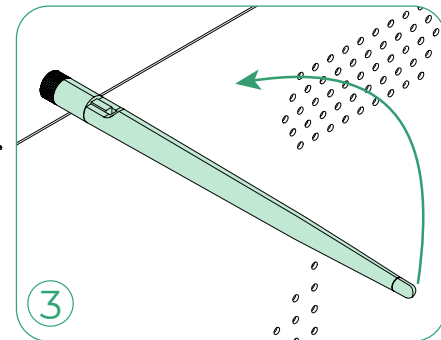
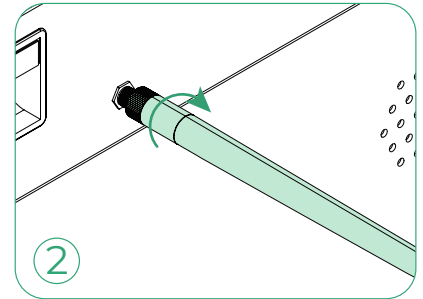
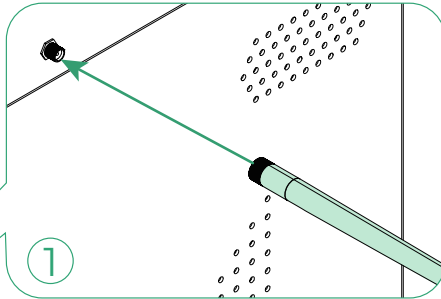
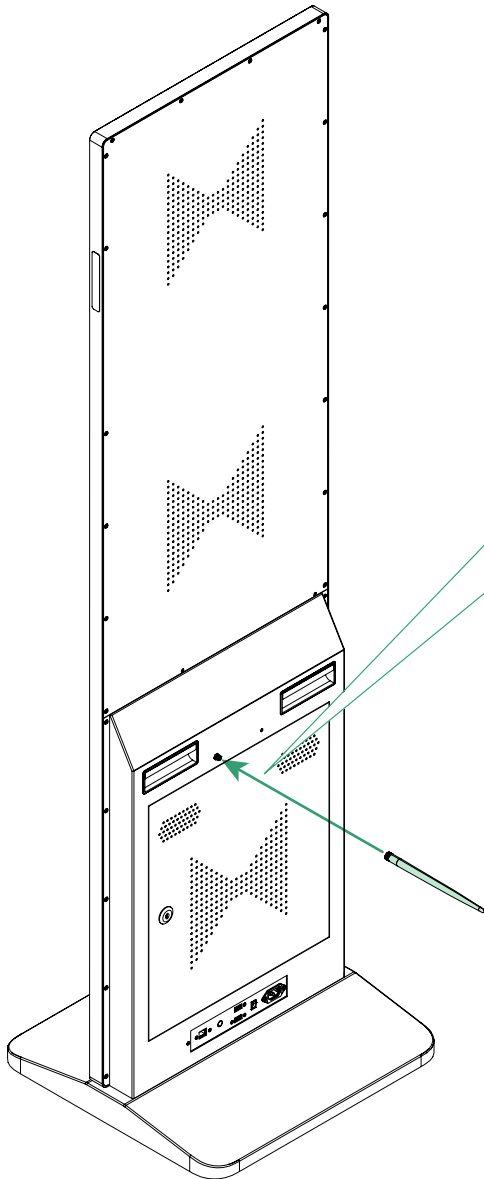
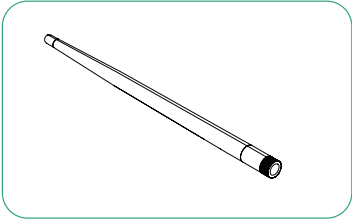

## Verwendung des xTool Standgerät für Self-Service-Kiosk

Schließen Sie das Netzkabel an und schalten Sie den Kiosk ein

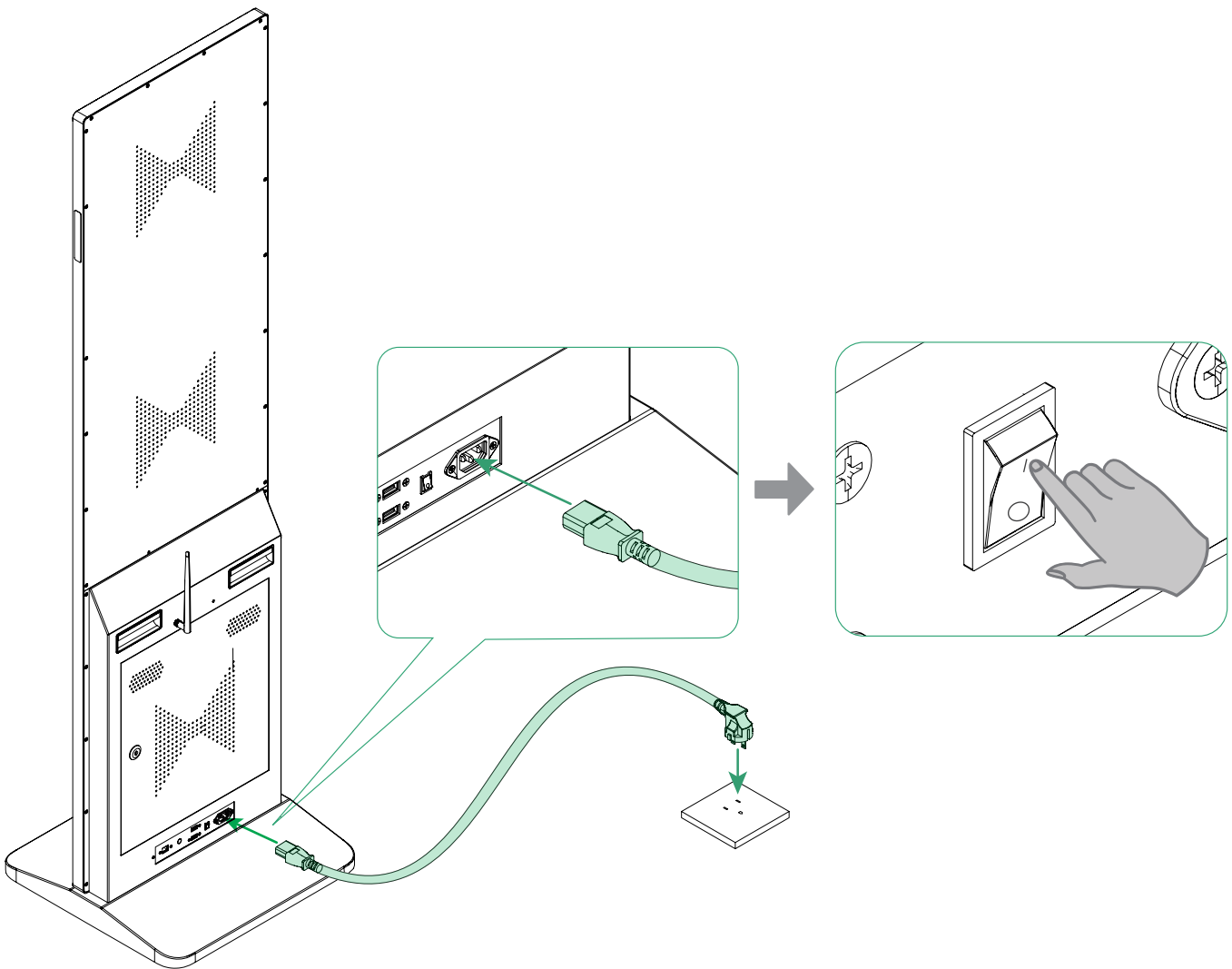
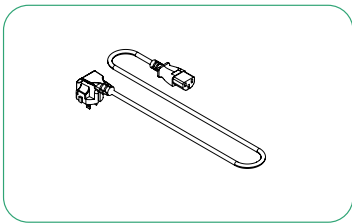

---

Scannen Sie den QR-Code oder öffnen Sie den angegebenen Link, um zu erfahren, wie Sie den Tablet in Kombination mit xTool-Maschinen zur Bearbeitung einsetzen.



[support.xtool.com/article/2087](https://support.xtool.com/article/2087)

**X**TOOL